

FRÄNKISCHE

INDUSTRIAL PIPES

Industrial cable protection

Product range for railway engineering
maintenance work

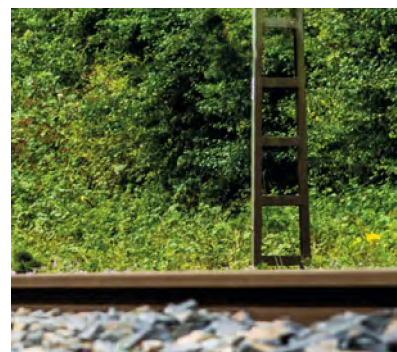
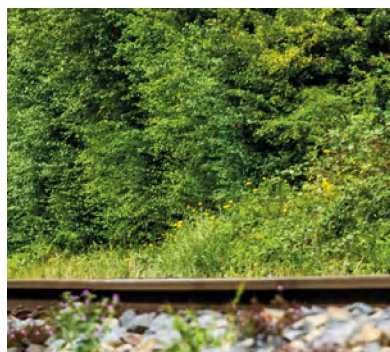
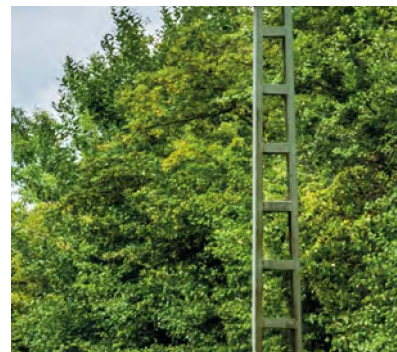

FIP SYSTEMS[®]

We simplify your world



Last modified: August 2022



FRÄNKISCHE Industrial Pipes: A world full of solutions

FRÄNKISCHE Industrial Pipes is a wholly-owned subsidiary of FRÄNKISCHE Rohrwerke, the world's first manufacturer of corrugated tubes. We develop products for the industrial and automotive sector in production facilities of more than 280,000 square meters worldwide with close focus on our customers' desires. Our international team of experts with their versatile skills strives to achieve the common goal: Making our customers' lives easier.

The broad competences of our experts are globally linked in order to stay close to the customer. With our broadly based teams of professionals we always try to see through the eyes of our customers and to perceive their needs. This is how we combine our and our customers' experiences in order to develop brand-new products and innovative solutions.

FIPSYSTEMS® We simplify your world

FIPSYSTEMS® a new developed innovative product range from FRÄNKISCHE Industrial Pipes, significantly simplifies the world of industrial cable protection. True to the motto "We simplify your world", FRÄNKISCHE Industrial Pipes and its FIPSYSTEMS® product line provides solutions to various challenges in the versatile field of industrial cable protection.

The sales and distribution of FIPSYSTEMS® is strongly supported by a global partner network. We work with qualified companies in virtually every country with industrial relevance to ensure fast and easy communication between you as a customer and us as a supplier. Our own locations in Europe, the United States and China supply the regional partners directly with the corresponding products which allow us to be more flexible regarding the delivery services all around the world.

You can find detailed contact data of our partners
at www.fipsystems.com

Rail approved cable protection solutions for functional safety

The highest level of safety is the top priority in railway and rail technology. In order to reliably protect sensitive cables and wires, FRÄNKISCHE Industrial Pipes developed high-quality cable protection products that are available in various material qualities for a wide range of requirements and also for retrofit installations.

FIPSYSTEMS® cable protection solutions

- reliable protection for exposed or sensitive cables and wires
- compliant with international fire protection regulations
- high dynamic load capacity
- good chemical and mechanical resistance
- excellent abrasion properties
- high weather resistance
- UV-resistant for up to 40 years
- individual solutions possible
- also for easy retrofitting
- broad range of accessories

Areas of application

- railway infrastructure
- track bed applications
- cabling in vehicles
- energy supply and data lines
- high voltage power lines
- ticket machines
- information systems
- video surveillance systems
- railway barriers
- rail sensors
- signaling, monitoring and control systems
- solutions for retrofitting / repair work



Railway/Transport



Track side

FIPLOCK[®] ONE

The new generation in cable protection:

FIPLOCK[®] ONE – ONE fits ALL

Pre-mounted FIPLOCK[®] ONE fitting made of specially formulated polyamide 6 ensures reliable connections between FIPLOCK[®] corrugated conduits with fine and coarse profile of NW 07 – NW 48. The pre-installed seal in the connector body ensures reliable connection with the highest possible IP-protection categories, since FIPLOCK[®] ONE can be used for protection classes 66, 67, 68 and 69. Therefore ONE fitting solution covers all application requirements. FIPLOCK[®] ONE provides a high level of weather resistance, high dynamic load capacity, impact resistance and pull-out strength, and meets the highest fire characteristic standards.

ONE FITS ALL.



ONE fitting for **ALL** applications

+ **pre-assembled** and **ready-to-fit**

+ **safe** and **reliable** connection

+ **lower** storage effort

+ **little** handling necessary

+ **cost savings**



Certificates and approvals

100 % reliability is our top priority. Therefore, our products are continuously tested internally and by independent, accredited testing institutes.



We meet all requirements of
DIN EN ISO 9001
ISO/TS 16949
ISO 50001 and
DIN EN ISO 14001



International Railway
 Industry Standard
ISOTS 22163



Communautés
 Européennes
 (IEC EN61386)



Registration,
 Evaluation,
 Authorization and
 restriction of **CH**emicals



Recognized component
 mark for Canada and
 United States



Restriction of
 Hazardous
 Substances directive



standards for rolling stock
EN 45545-2



License for transport
 of hazardous goods



**American Society for
 Testing and Materials**



Halogen-free



**National Fire Protection
 Association**



Standard for fire behavior
 of vehicle interiors
 according to guideline
UNECE 118

Standard corrugated conduit profiles

F Fine profile

- fine profile pitch over convolution top and convolution bottom
- more convolutions per length provide an optimized distribution of bending stress to the material
- suitable for tighter bending radii and lower bending stiffness
- compatible with our FIPLOCK® ONE fittings and FIPLOCK® accessories

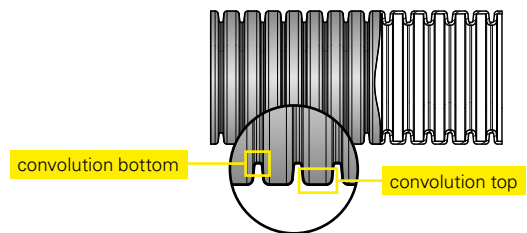

C Coarse profile

- coarse profile pitch over convolution top and convolution bottom
- less convolutions per length reduces the conduit elongation under pulling forces
- suitable for increased pull out forces at heavy loads
- compatible with our FIPLOCK® ONE fittings and FIPLOCK® accessories

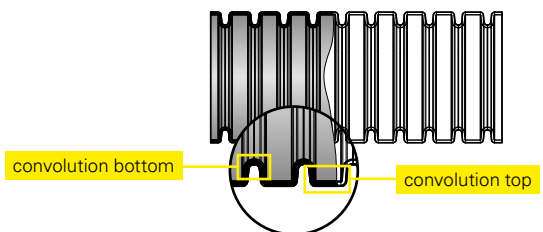

M Intermediate profile

- wider profile pitch as for the fine profile, for gripping the outer tube properly to the inner tube
- optimized profile for different applications where the corrugated conduits remain closed also at tight bending radii
- suitable for retrofit applications of cable protection, also pre-assembled cable harnesses with already installed connectors
- compatible with our FIPSPLIT® fittings and accessories

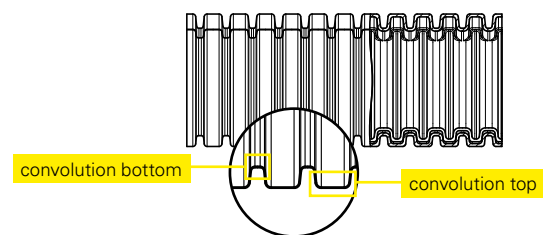

Further profiles upon request. More information at www.fipsystems.com

Fittings

FIPLOCK® ONE

































fittings made of specially formulated polyamide 6 (PA6 MOD V0 SGA) enable a reliable connection of FIPLOCK® corrugated conduits with fine and coarse profiles. The pre-installed seal in the connection body enables a secure connection with maximum connection strength and is particularly suitable for use in railway technology, even under demanding environmental conditions. Do not worry any more about the required IP tightness and protection classes – ONE FITS ALL – up to IP69.

FIPLOCK® ONE is available in different versions of the body and optionally with plastic or metal threads. Some of these are also available in different lengths and thread types, as well as in a revolving version.































All fittings meet the highest fire protection requirements according to EN45545-2 with HL3 for R22 / R23.



































Use this QR code to get directly to our FIPLOCK® ONE product range.

























Product		Version	Version thread	EN 45545-2	ASTM + NFPA 130	UL 94			Data-sheet
Body	Version								
ASPA	M		Plastic	HL3	✓	V0	✓	✓	
	MMK		Metal short	HL3	✓	V0	✓	✓	
	MMK-S		Metal short revolving	HL3	✓	V0	✓	✓	
	MML		Metal long	HL3	✓	V0	✓	✓	
	MML-S		Metal long revolving	HL3	✓	V0	✓	✓	
	PG		Plastic	HL3	✓	V0	✓	✓	
	PGM		Metal	HL3	✓	V0	✓	✓	
	PGM-S		Metal revolving	HL3	✓	V0	✓	✓	
	NPT		Plastic	HL3	✓	V0	✓	✓	
	NPTM-S		Metal revolving	HL3	✓	V0	✓	✓	
AWPA / AEPA	M		Plastic	HL3	✓	V0	✓	✓	
	MMK		Metal short	HL3	✓	V0	✓	✓	
	MMK-S		Metal short revolving	HL3	✓	V0	✓	✓	
	MML		Metal long	HL3	✓	V0	✓	✓	
	MML-S		Metal long revolving	HL3	✓	V0	✓	✓	

Fittings

Product		Version thread	EN 45545-2	ASTM + NFPA 130	UL 94			Data-sheet	
Body	Version								
AWPA / AEPA	PG		Plastic	HL3	✓	V0	✓	✓	
	PGM		Metal	HL3	✓	V0	✓	✓	
	PGM-S		Metal revolving	HL3	✓	V0	✓	✓	
	NPT		Plastic	HL3	✓	V0	✓	✓	
	NPTM-S		Metal revolving	HL3	✓	V0	✓	✓	
AAPA	M		Plastic	HL3	✓	V0	✓	✓	
	MMK		Metal short	HL3	✓	V0	✓	✓	
	MMK-S		Metal short revolving	HL3	✓	V0	✓	✓	
	MML		Metal long	HL3	✓	V0	✓	✓	
	MML-S		Metal long revolving	HL3	✓	V0	✓	✓	
	PG		Plastic	HL3	✓	V0	✓	✓	
	PGM		Metal	HL3	✓	V0	✓	✓	
	PGM-S		Metal revolving	HL3	✓	V0	✓	✓	
	NPT		Plastic	HL3	✓	V0	✓	✓	
	NPTM-S		Metal revolving	HL3	✓	V0	✓	✓	

Product		Version thread	EN 45545-2	ASTM + NFPA 130	UL 94			Data-sheet	
Body	Version								
AFPA	M		Plastic	HL3	✓	V0	✓	✓	
	MM		Metal short	HL3	✓	V0	✓	✓	
	PG		Plastic	HL3	✓	V0	✓	✓	
	PGM		Metal	HL3	✓	V0	✓	✓	
	U-M		Plastic	HL3	✓	V0	✓	✓	
	U-A		Plastic	HL3	✓	V0	✓	✓	
	U-B		Plastic	HL3	✓	V0	✓	✓	
AZPA	M		Plastic	HL3	✓	V0	✓	✓	
	C		Plastic	HL3	✓	V0	✓	✓	
	MMK		Metal short	HL3	✓	V0	✓	✓	
	MML		Metal long	HL3	✓	V0	✓	✓	
	PG		Plastic	HL3	✓	V0	✓	✓	
	PGM		Metal	HL3	✓	V0	✓	✓	
	NPT		Plastic	HL3	✓	V0	✓	✓	
	NPTM		Metal	HL3	✓	V0	✓	✓	

Fittings

Product		Version thread	EN 45545-2	ASTM + NFPA 130	UL 94			Data-sheet	
Body	Version								
ATPA			HL3	✓	V0	✓	✓		
ATPA-CA			HL3	✓	V0	✓	✓		
AYPA			HL3	✓	V0	✓	✓		
ARPA			HL3	✓	V0	✓	✓		
AIPA	M		Stainless steel bride	HL3	✓	V0	✓	✓	
	PG		Stainless steel bride	HL3	✓	V0	✓	✓	
ACPA			HL3	✓	V0	✓	✓		
ACPA-SH			HL3	✓	V0	✓	✓		
APPA	EPDM		EPDM flange seal	HL3	✓	V0	✓	✓	
	NBR		NBR flange seal	HL3	✓	V0	✓	✓	
ASPA-HV			HL3	✓	V0	✓	✓		

Multiple conduit mounting rail BRPA

Optimizing process costs and saving time



- stackable and therefore space-saving
- simple mounting with only one mounting screw or threaded rod
- available in versions with **2, 3 or 4** conduit ducts

Corrugated conduits and accessories

FIPLOCK® corrugated conduits

ensure highly reliable mechanical cable protection and flexible routing of wires and cables.

The products listed here can be used in many ways and are ideally suited for rail-technical applications (rolling stock and track side applications).







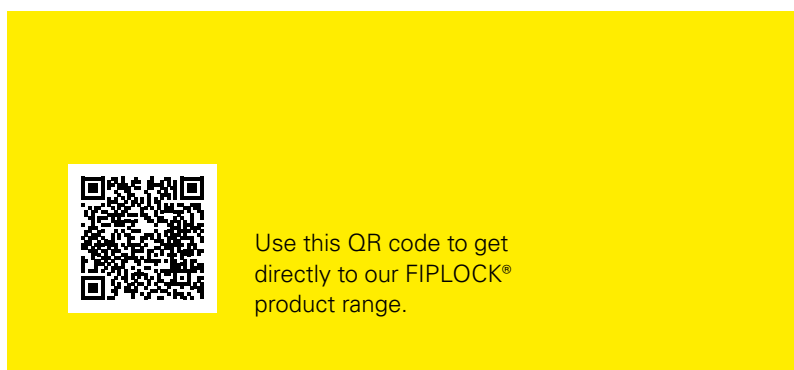
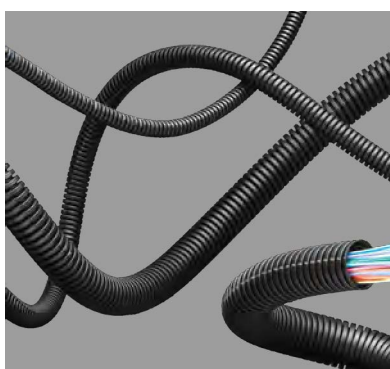







FIPLOCK® corrugated conduits for other areas of application can be found in our main catalogue or on our website www.fipsystems.com. They are available in different material qualities depending on the requirements.

FIPLOCK® accessories

complete our high-quality cable protection product range and are suited for FIPLOCK® corrugated conduits with fine and coarse profiles. These include among others, mounting clips, mounting rails, system support, corrugated conduit/tube clamps, edge protections and termination sleeves, lock-nuts, thread enlarger and much more useful accessories out of plastic or nickel-plated brass.



































Corrugated conduits





















Products		Material	Profile	EN 45545-2	ASTM + NFPA 130	UL 94			Data-sheet
FPAS		PA6 MOD BS <i>Standard version</i>	F, C	HL3 R22 HL3 R23	✓	V2 (V0)	✓		
FPAF		PA6 MOD V0 <i>Standard version</i>	F, C	HL3 R22 HL3 R23		V0	✓		
HPAF		PA6 MOD V0 <i>Heavy version</i>	F, C	HL2 R22 black HL3 R23 grey		V0	✓		
FPDS		PA12 MOD BS <i>Standard version</i>	F, C	HL3 R22 HL3 R23	✓	V2	✓	✓	
HPDS		PA12 MOD BS <i>Heavy version</i>	F, C	HL3 R22 HL3 R23	✓	V2	✓	✓	
FPPS-U		PP MOD BS UV <i>Standard version</i>	F, C			V2		✓	

Choosing the right corrugated conduit for a specific application is of great importance and decisive for a suitable installation. We and our sales partners are happy to help.







We also advise our customers on an optimal, application-specific design and installation, for the most effective and efficient cable protection solutions. Contact us and take advantage of our many years of experience.

Accessories

Products		Material	EN 45545-2	ASTM + NFPA 130	UL 94			Data-sheet
COPA-S		PA6 MOD V0 SGA	HL3	✓	V0	✓	✓	
COPA-H		PA6 MOD V0 SGA	HL3	✓	V0	✓	✓	
CRPA / CXPA		PA6 MOD V0 SGA	HL3	✓	V0	✓	✓	
BSPA		PA6 MOD V0 SGA	HL3	✓	V0	✓	✓	
BSPA-BJ		PA6 MOD V0 SGA	HL3	✓	V0	✓	✓	
BRPA		PA6 MOD V0 SGA	HL3	✓	V0	✓	✓	
CPPA		PA6 MOD V0 SGA	HL3	✓	V0	✓	✓	
CUPA		PA6 MOD V0 SGA	HL3	✓	V0	✓	✓	
CPSZ		Galvanized steel and EPDM				✓	✓	
CUSZ		Galvanized steel and EPDM				✓	✓	
PETP		TPE			V0	✓	✓	
PTTP		TPE			V0	✓	✓	
NTPA-M		Polyamide (glass fiber reinforced)			HB	✓	✓	
NTBN-M		Nickel-plated brass				✓	✓	
NTPA-PG		Polyamide (glass fiber reinforced)			HB	✓	✓	

Products		Material	EN 45545-2	ASTM + NFPA 130	UL 94			Data-sheet
NTBN-PG		Nickel-plated brass				✓	✓	
NEPA-M		Polyamide (glass fiber reinforced)			HB	✓	✓	
NEBN-M		Nickel-plated brass				✓	✓	
NRPA-M		Polyamide (glass fiber reinforced)			HB	✓	✓	
NRBN-M		Nickel-plated brass				✓	✓	
NKPA		PA6 MOD V0 SGA	HL3	✓	V0	✓	✓	
PAPA		PA6 MOD V0 SGA	HL3	✓	V0	✓	✓	
BHPA		PA6 MOD V0 SGA	HL3	✓	V0	✓	✓	
TDPA		PA66				✓	✓	

Accessories XL

Products		Material	EN 45545-2	ASTM + NFPA 130	UL 94			Data-sheet
JSPA		PA6 MOD V0 SGA	HL3	✓	V0	✓	✓	
JWPA		PA6 MOD V0 SGA	HL3	✓	V0	✓	✓	

FIPLOCK® ONE

suitable for various industrial connectors



FIPLOCK® ONE
AFPA
for Souriau UT66
connectors



FIPLOCK®
ONE AFPA
for MIL DTL 5015
connectors



FIPLOCK®
ONE AFPA
for TE DEUTSCH HDP
series connectors

FIPLOCK® ONE

FIPLOCK® ONE AFPA

for MIL DTL 5015
connectors



FIPLOCK® ONE AZPA-MML

for industrial
connectors



High temperature corrugated conduits

FIPHEAT[®]

is the product line of corrugated conduits meeting the highest temperature requirements. The high-tech materials used boast performance features that meet the highest requirements in terms of temperature as well as chemical resistance. The products are available in the usual industrial nominal widths and are an indispensable solution for specific application requirements.



Product	Material	Profile	ASTM + NFPA 130	UL 94			Data-sheet
FPKS	PEEK	F/C		V0	✓	✓	

Further types upon request

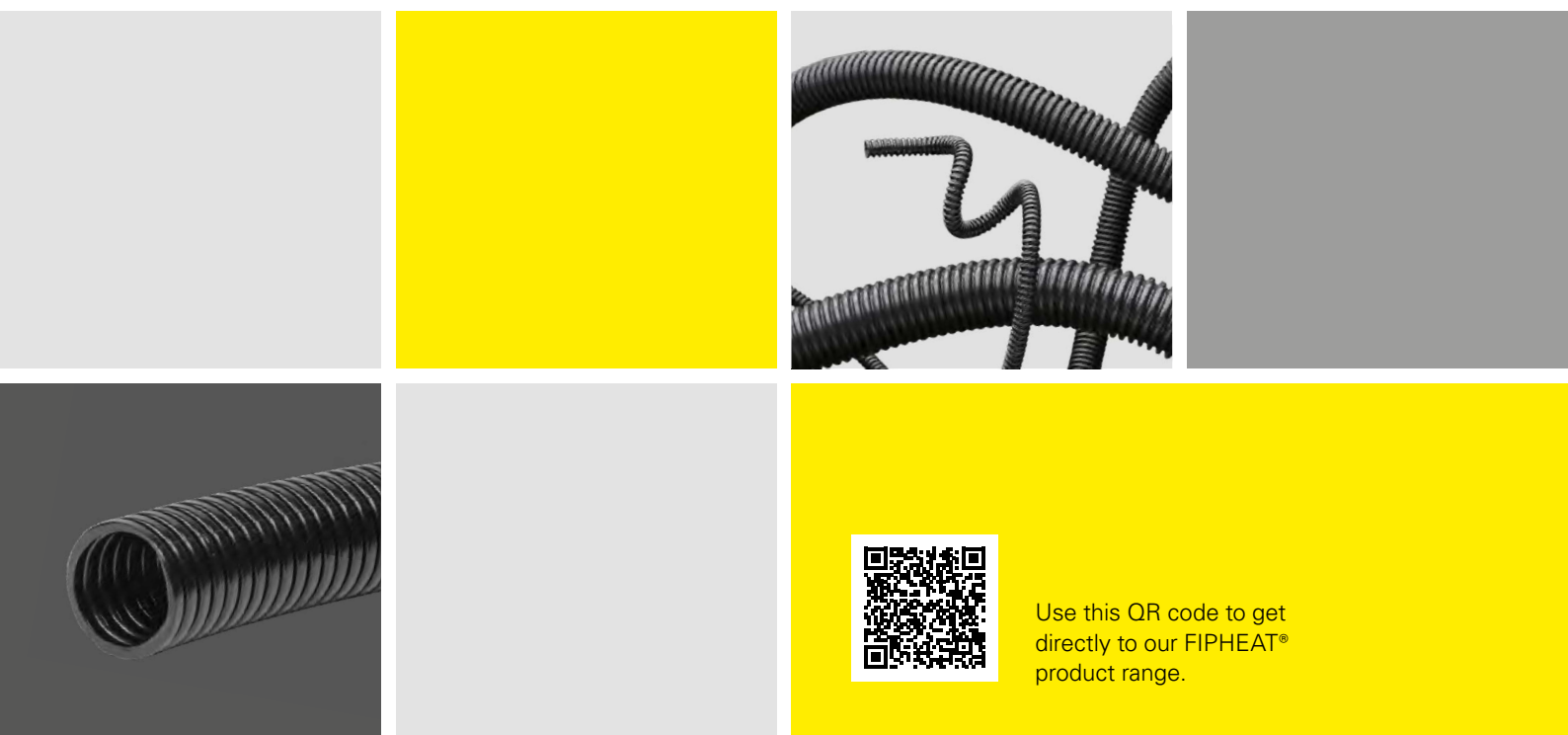







Textile protection sleeves

FIPJACK®

comprises a broad range of textile protection sleeves. These serve for the simple bundling of strands and cables. They offer good abrasion protection, high resistance to the penetration of sharp objects and in some cases meet the highest fire protection requirements.

Self-wrapping fabric hoses are ideal for retrofit installations over already laid and connected lines.

Products	Material	EN 45545-2	ASTM + NFPA 130	UL 94			Data-sheet
BPET-V0 	PET V0	✓	HL3 R22 HL3 R23	V0	✓	✓	
WPET-SCF 	PET V0	✓	HL3 R22 HL3 R23	V0	✓	✓	

Further types upon request

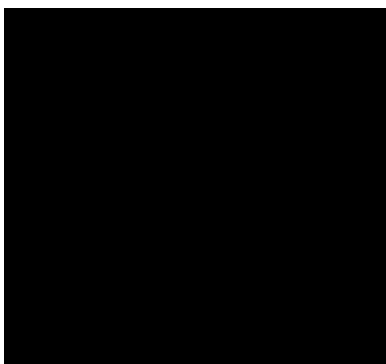



Use this QR code to get directly to our FIPJACK® product range.

Divisible corrugated conduits and accessories









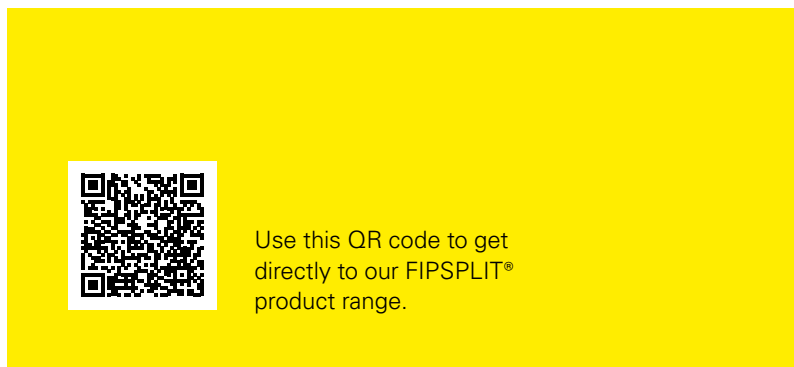
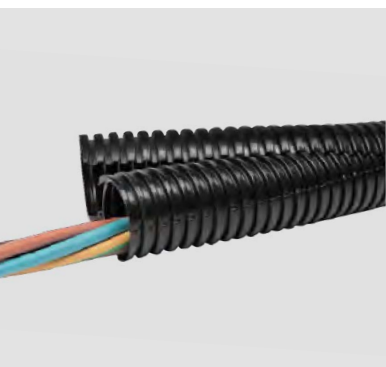
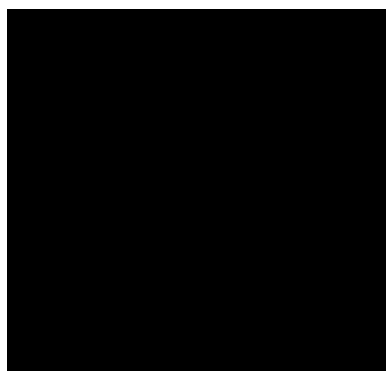
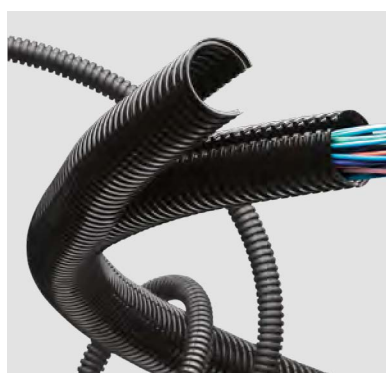

















FIP SPLIT[®]

are divisible corrugated conduits and the ideal solution for cable protection to be retrofitted. Even for retrofitting of already assembled cable harnesses with mounted plugs. Due to the overlapping of the lockable "double conduit", inserted cables and wires are effectively protected against external influences. FIP SPLIT[®] conduits are available in diameters from 4 mm to 100 mm.

FIP SPLIT[®] accessories

complete our high-quality cable protection product range and are suitable for our FIP SPLIT[®] divisible corrugated conduits. These include mounting clips, conduit connectors, divisible fittings and divisible locknuts in different sizes.



Products		Material	Profile	EN 45545-2	ASTM + NFPA 130	UL 94			Data-sheet
2PPS-U		PP MOD BS	M			V2		✓	
2PAS		PA6 MOD BS	M	HL3 R22 HL3 R23	✓	V2 (V0)	✓		
2PAF		PA6 MOD V0	M	HL3 R22 HL3 R23		V0	✓		
2PDS		PA12 MOD BS	M	HL3 R22 HL3 R23	✓	V2	✓	✓	
1PAS		PA6 MOD BS	M	HL3 R22 HL3 R23	✓	V2 (V0)	✓		
1PPS-U		PP MOD BS UV	M			V2		✓	
2CNPA		PA6 MOD BS SGA				V2	✓	✓	
2CPA		PA6 MOD BS SGA				V2	✓	✓	
2SPA-M		PA6 MOD BS SGA				V2	✓	✓	
2NTPA-M		PA6 MOD BS SGA				V2	✓	✓	
2SPA-PG		PA6 MOD BS SGA				V2	✓	✓	
2NTPA-PG		PA6 MOD BS SGA				V2	✓	✓	

Further types upon request







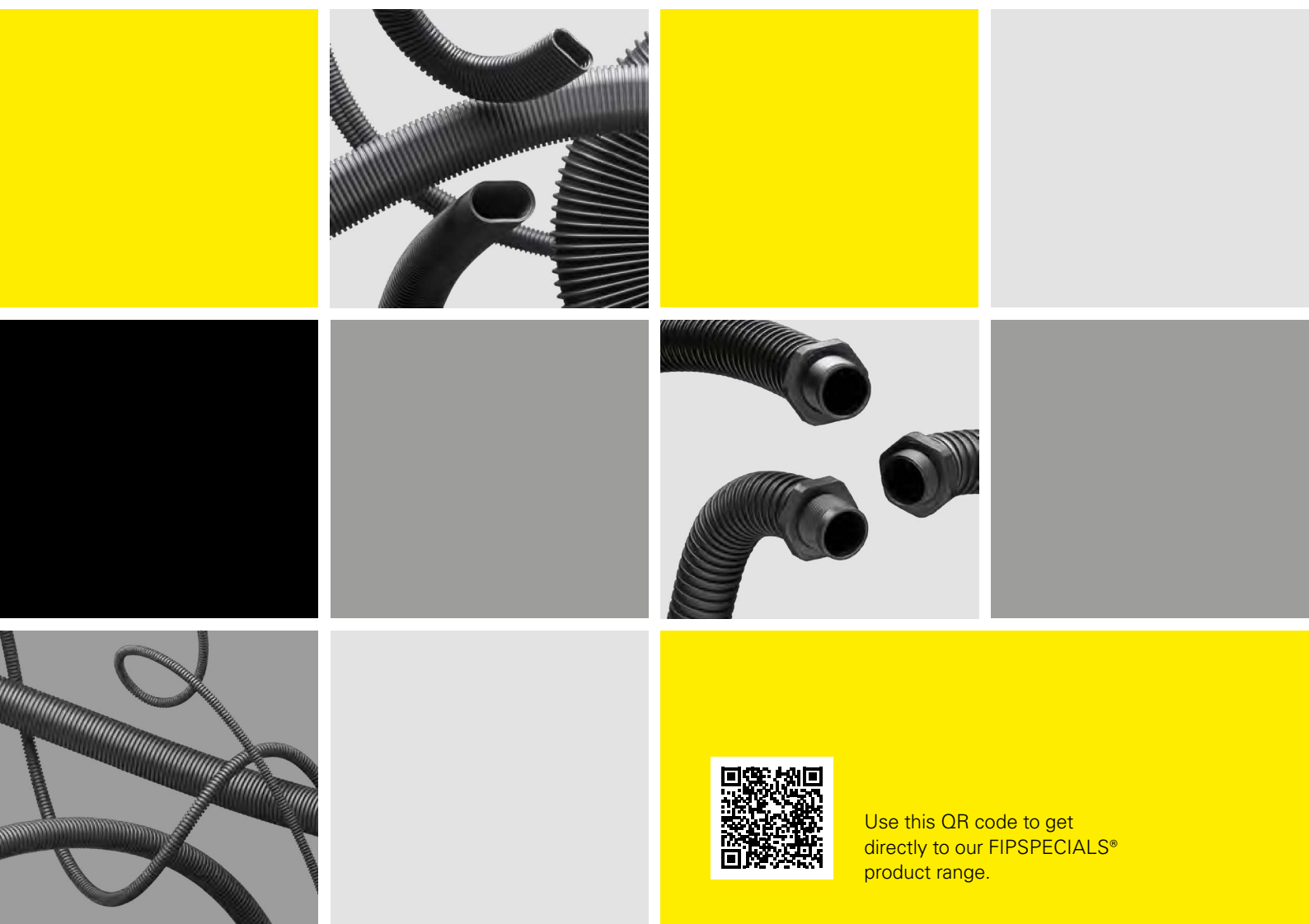









Special solutions

FIP SPECIALS[®]

is the product group for extraordinary solutions such as segmented conduit systems, corrugated conduits with an integrated thread connection, special shapes for customized installation, square, hexagonal, oval corrugated conduits, or even multi-layer corrugated conduits (co-extrusion) – to mention just a few.



Use this QR code to get directly to our FIP SPECIALS[®] product range.

Products		Material	Profile	EN 45545-2	ASTM + NFPA 130	UL 94			Data-sheet
IPAT		PA6 MOD BS	F	HL3 R22 HL3 R23	✓	V2 (V0)	✓		
OPAS		PA6 MOD BS	F	HL3 R22 HL3 R23	✓	V2 (V0)	✓		
OPAF		PA6 MOD V0	F	HL3 R22 HL3 R23		V0	✓		
OPDS		PA12 MOD BS	F	HL3 R22 HL3 R23	✓	V2	✓	✓	
DPSS-U		PP MOD BS UV	X			V2	✓	✓	
FPASH		PA6 MOD BS	H	HL3 R22 HL3 R23	✓	V2 (V0)	✓		
FPASS		PA6 MOD BS	S	HL3 R22 HL3 R23		V2 (V0)	✓		

EMV shielding solutions







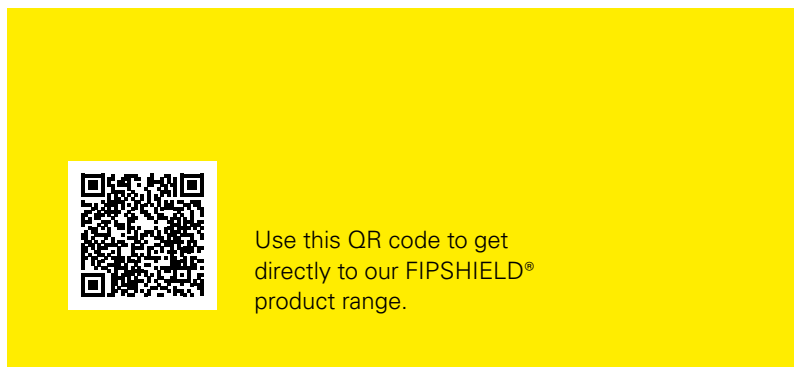
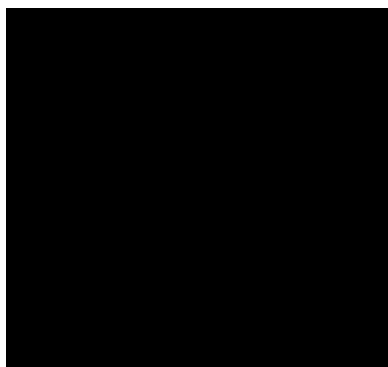
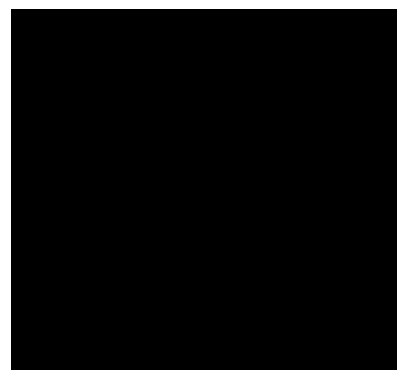
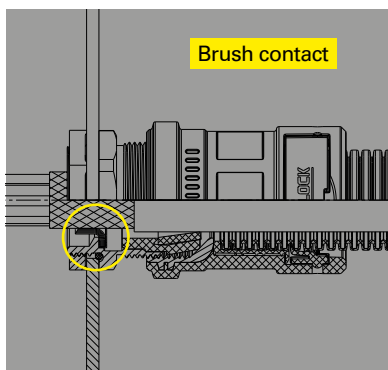
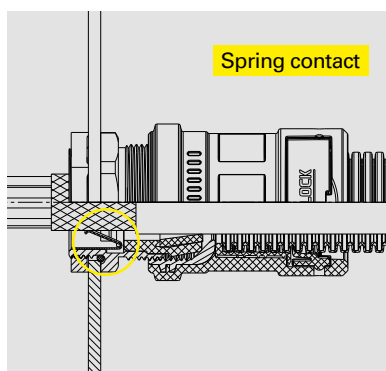





FIPSHIELD®

The FIPSHIELD® product line contains products for the electromagnetic shielding of sensitive cables and data lines in order to meet the requirements of industrial EMC guidelines (electromagnetic compatibility).









FIPSHIELD® accessories enable an optimal electrical transition from the braided screen to the connection housing for a high screening effect with low transfer impedance. The fittings contain the tried and tested FIPLOCK® ONE connection for the matching FIPLOCK® corrugated conduits.



Fittings

Products		Material thread version	EN 45545-2	ASTM + NFPA 130	UL 94			Data- sheet
EZPA-C-MMK (Brush)		PA6 MOD V0 SGA Metal short	HL3	✓	V0	✓	✓	
EZPA-D-MMK (Spring)		PA6 MOD V0 SGA Metal short	HL3	✓	V0	✓	✓	
EZPA-D-PGM (Spring)		PA6 MOD V0 SGA Metal short	HL3	✓	V0	✓	✓	
EZPA-C-NPTM (Brush)		PA6 MOD V0 SGA Metal short	HL3	✓	V0	✓	✓	
EZPA-D-NPTM (Spring)		PA6 MOD V0 SGA Metal short	HL3	✓	V0	✓	✓	

Accessories

Products		Material	EN 45545-2	ASTM + NFPA 130	UL 94			Data- sheet
ENTBN-M-C		Nickel-plated brass				✓	✓	
NTBN-M-EMV		Nickel-plated brass				✓	✓	
NTBN-PG-EMV		Nickel-plated brass				✓	✓	

FRÄNKISCHE

INDUSTRIAL PIPES

Rooted in Königsberg – globally successful!

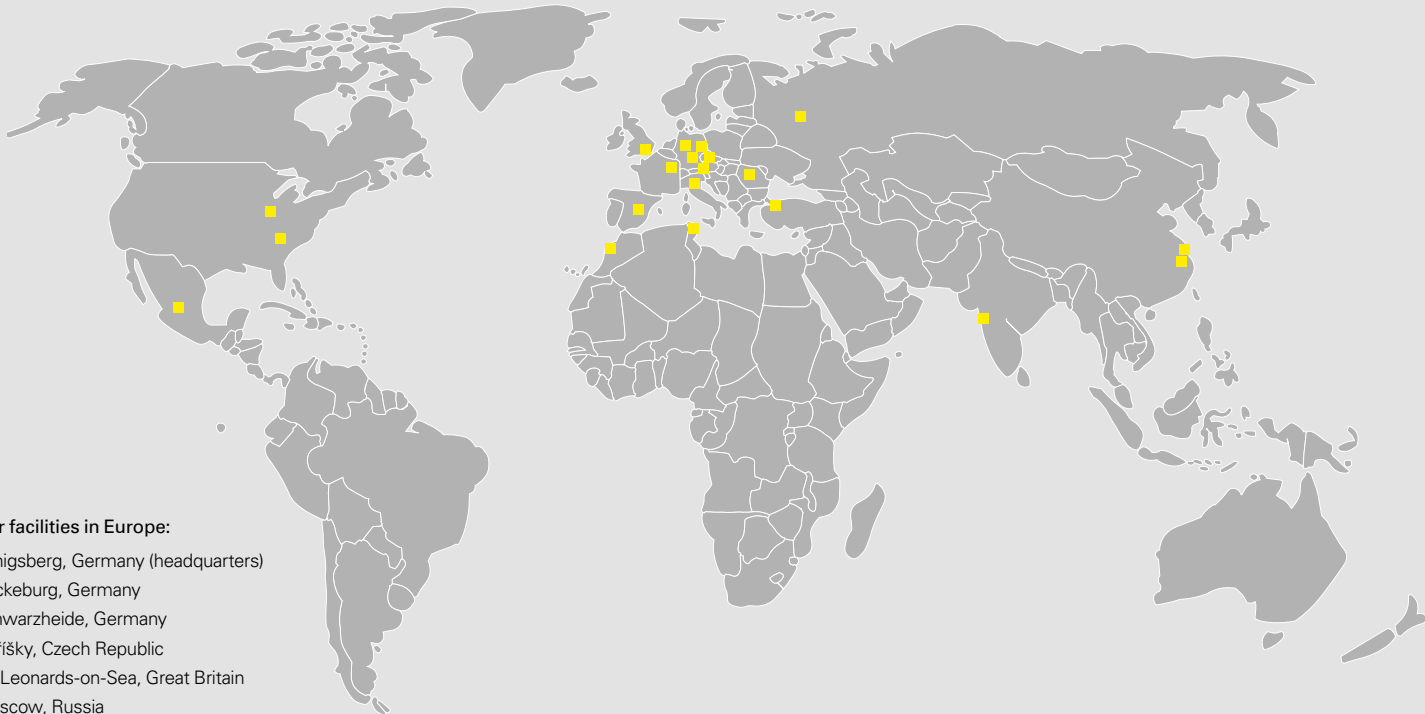

Our facilities in Europe:

- Königsberg, Germany (headquarters)
- Bückeberg, Germany
- Schwarzheide, Germany
- Okříšky, Czech Republic
- St.-Leonards-on-Sea, Great Britain
- Moscow, Russia
- Yeles/Toledo, Spain
- Torcy-le-Grand, France
- Ebersbach/Fils, Germany
- Hermisdorf, Germany
- Milan, Italy
- Istanbul, Turkey
- Cluj, Romania
- Wels, Austria

Our facilities in North America and Mexico:

- Anderson, USA
- Rochester Hills, USA
- Silao, Mexico

Our facilities in Africa:

- Ben Arous, Tunisia
- Casablanca, Morocco

Our facilities in Asia:

- Anting/Shanghai, China
- Hangzhou, China
- Changshu, China
- Pune, India

FRÄNKISCHE is an industry leader in the design, manufacturing and marketing of technically superior pipe systems, shafts and system components made of plastic and metal, and offers solutions for building construction, civil engineering, automotive and industrial applications.

Founded in 1906, the company is a third-generation family-owned business with around 5,000 employees working at production and sales facilities around the globe.

